

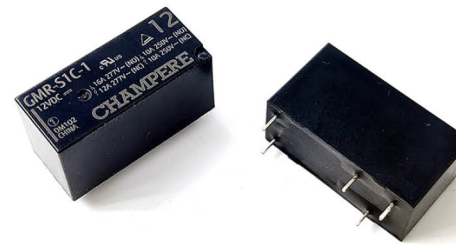

GMR. SUBMININATURE POWER RELAY

FEATURES

- ▶ 28.8 X 12.5 X 15.5(H) MM.
- ▶ 20A MAX SWITCHING CAPACITY, SUITABLE FOR COMPLEX LOAD.
- ▶ DIELECTRIC VOLTAGE UP TO 5KV.
- ▶ CREEPAGE DISTANCE > 8MM.
- ▶ UL CLASS F AND GLOW WIRE VERSION AVAILABLE.



 File Number: E516488
 File Number: R50472784

CONTACT RATINGS			
Contact Form	1A, 1B, 1C, 2A, 2B, 2C		
Contact Resistance	≤100mΩ (1A 6VDC)		
Contact Material	Ag Alloy (AgSnO ₂ , AgSnO ₂ In ₂ O ₃ , AgNi)		
Rated Load (Resistive)	FORM A	FORM C	
		NO	NC
	20A 277VAC (1A Type) 16A 30VDC (1A Type) 12A 250VAC (2A Type) 8A 30VDC (2A Type)	20A 277VAC (1C Type) 16A 30VDC (1C Type) 12A 277VAC (2C Type) 8A 30VDC (2C Type)	16A 277VAC (1C Type) 16A 30VDC (1C Type) 8A 277VAC (2C Type) 8A 30VDC (2C Type)
Max. Switching Current	20A (1 Pole) 12A (2 Poles)		16A (1 Pole) 8A (2 Poles)
Max. Switching Power	5,540VA / 480W (1 Pole) 3,000VA / 240W (2 Poles)		4,432VA / 480W (1 Pole) 2,216VA / 240W (2 Poles)
Max. Switching Voltage	277VAC / 30VDC		
Min. Permissible Load	100mA at 5VDC		

CHARACTERISTICS			
Operate Time	≤ 15ms		
Release Time	≤ 10ms		
Insulation Resistance	1,000MΩ (500VDC)		
Dielectric Strength	I / O	O / O	
	5,000VAC 1min		1,000VAC 1 min
Impulse Withstand Voltage	10 kV (1.2 x 50μs)		
Shock Resistance	Non-energized	Destruction	Malfunction
	100 m/s ² (10G)	1,000 m/s ² (100G)	100 m/s ² (10G)
Vibration Resistance	Destruction		Malfunction
	10 to 55 Hz, (1.5mm double amplitude)		10 to 55 Hz, (1.5mm double amplitude)
Ambient Temperature	Operating: -40°C to +105°C with no icing or condensation		
Ambient Humidity	Operating: 5% to 85%		
Mount Type	PCB Pins		
Weight	Approx. 13g		

NOTE: The data shown above are initial values.

COIL DATA					
DC Standard	Approx. 400mW				
Rated Voltage (VDC)	Operate Voltage (VDC)	Release Voltage (VDC)	Max. Voltage (VDC)	Nominal Current (mA)	Coil Resistance (Ω) ±10%
5	≤3.75	≥0.25	6.5	80	62.6
12	≤9	≥0.6	15.6	33.3	360
24	≤18	≥1.2	31.2	16.7	1,440
48	≤36	≥2.4	62.4	8.3	5,760
110	≤82.5	≥5.5	143	3.64	30,250
DC Sensitive	Approx. 250mW				
Rated Voltage (VDC)	Operate Voltage (VDC)	Release Voltage (VDC)	Max. Voltage (VDC)	Nominal Current (mA)	Coil Resistance (Ω) ±10%
5	≤4	≥0.25	6.5	50	100
12	≤9.6	≥0.6	15.6	20.8	576
24	≤19.2	≥1.2	31.2	10.4	2,304
AC Coil	Approx. 0.75VA				
Rated Voltage (VAC)	Operate Voltage (VAC)	Release Voltage (VAC)	Max. Voltage (VAC)	Nominal Current (mA)	Coil Resistance (Ω) ±10%
24	≤19.2	≥3.6	31.2	31.6	350
220/230	≤184	≥34.5	286	3.2	32,500

LIFE EXPECTANCY DATA		
Mechanical Life Expectancy	10,000,000 Operations	
Electrical Life Expectancy	FORM A	FORM C
	1A TYPE: 50,000 Operations (20A 277VAC Resistive Load, 1s ON / 9s OFF)	1C TYPE: 50,000 Operations (NO: 20A / NC: 16A 277VAC Resistive Load, 1s ON / 9s OFF)
	1A TYPE: 100,000 Operations (16A 277VAC Resistive Load, 1s ON / 9s OFF)	1C TYPE: 80,000 Operations (NO: 16A / NC: 16A 277VAC Resistive Load, 1s ON / 9s OFF)
	2A TYPE: 50,000 Operations (12A 277VAC Resistive Load, 1s ON / 9s OFF)	2C TYPE: 50,000 Operations (NO: 12A / NC: 8A 277VAC Resistive Load, 1s ON / 9s OFF)

NOTE: The electrical life data items shown are possible at 23°C

SAFETY APPROVALS

	Coil Rating	Contact Rating	
		NO	NC
ULus / cUL TV-8	3 to 48VDC, 60VDC, 110VDC	20A 277VAC 85°C 50,000 Cycles (1 Pole) 16A 277VAC 105°C 80,000 Cycles (1 Pole) 16A 277VAC 85°C 100,000 Cycles (1 Pole) 12A 277VAC 85°C 50,000 Cycles (2 Poles) 8A 277VAC 105°C 80,000 Cycles (2 Poles)	16A 277VAC 85°C 100,000 Cycles (1 Pole) 8A 277VAC 85°C 50,000 Cycles (2 Poles)
TUV	3 to 48VDC, 60VDC, 110VDC	20A 250VAC 85°C 100,000 Cycles (1 Pole) 16A 250VAC 105°C 100,000 Cycles (1 Pole) 12A 250VAC 85°C 100,000 Cycles (2 Poles) 8A 250VAC 105°C 100,000 Cycles (2 Poles)	16A 250VAC 85°C 100,000 Cycles (1 Pole) 8A 250VAC 85°C 100,000 Cycles (2 Poles)

ORDERING INFORMATION

Type	Contact / Seal Key	Variation Key	Coil Key
GMR	S 1 A Q	L F 2	24 VDC or VAC
Seal Type	Nil: Flux Proof; S: Plastic Sealed		X / XX / XXX (3 ~ 230): DC / AC Coil Voltage Value Coil Voltage
NO of Pole	1: Single Pole; 2: Double Pole		1: 3.5mm Contact Pin Pitch (for 1 Pole Only); 2: 5mm Contact Pin Pitch Pin Pitch
Contact Form	A: Form A / Normally Open; B: Form B / Normally Close; C: Form C / Change Over		Nil: Standard Insulation; F: Class F Insulation Insulation Class
Contact Material	Nil: Silver Alloy (ROHS Compliant); D: Silver Alloy: AgCdO; Q: Silver Alloy: AgNi for Cont. Current (ROHS)		Nil: Standard DC Coil: 0.4W, Standard AC Coil 0.75VA; L: Sensitive Coil: 0.25W Power Consumption

Example: GMR-1A-2/12VDC stands for 1 FORM A GMR relay with 5mm pin pitch, coil voltage is 12VDC. For full list of ordering codes please visit our website.

ENGINEERING DATA

Coil Temperature Rise
Ambient Temp.: 70°C; Measure Distance: 10mm

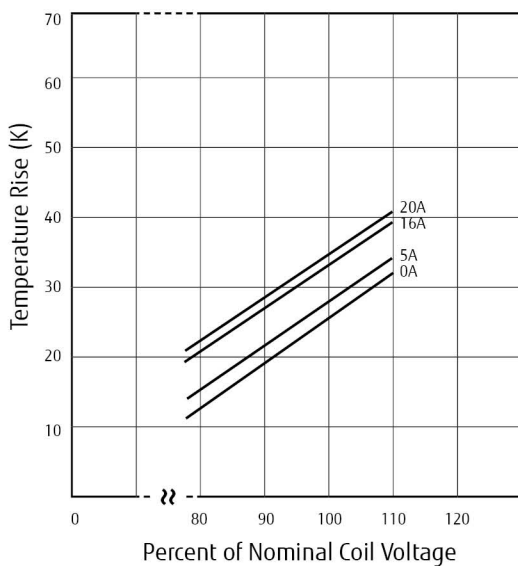

Electrical Endurance Curve
NO: 277VAC Resistive 1s ON / 1s OFF

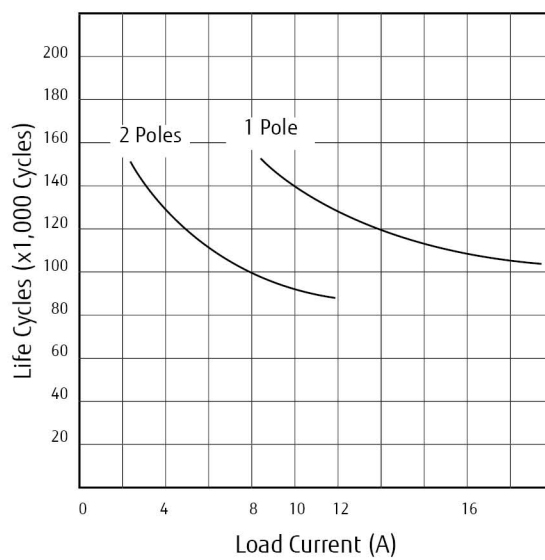

Max. Switching Capacity

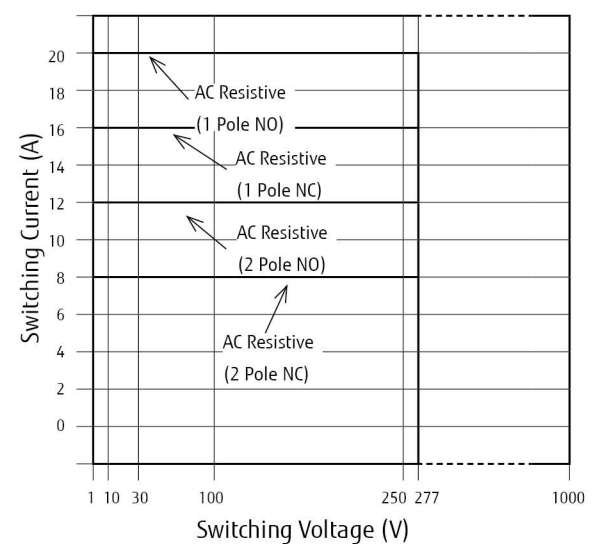

DIMENSIONS (UNIT: MM)

Outline Dimensions

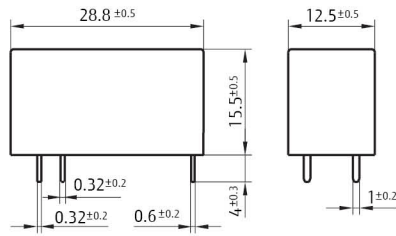

PCB Layout (Bottom View)

PIN PITCH 1 - FORM A

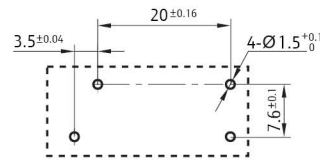

Wiring Diagram



1 Pole

PIN PITCH 1 - FORM C

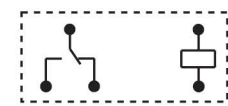
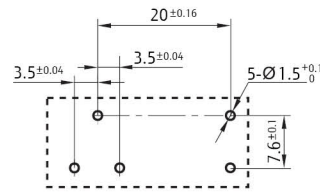

1 Pole

PIN PITCH 2 - FORM A

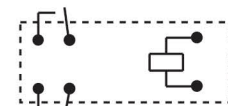
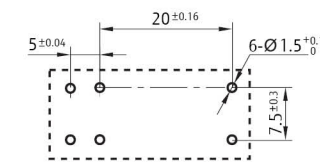
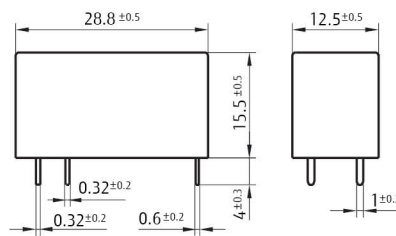

2 Poles

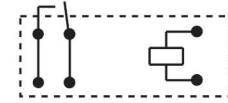

1 Pole

PIN PITCH 2 - FORM C

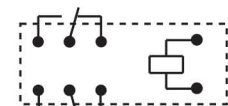
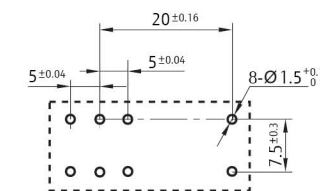
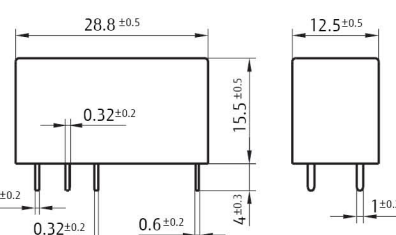

2 Poles

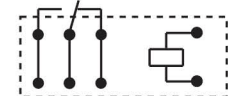

1 Pole

PRINT LAYOUT

Below layout is for reference only.

TOP PRINTING

LASER PRINTED ON BLACK CASE

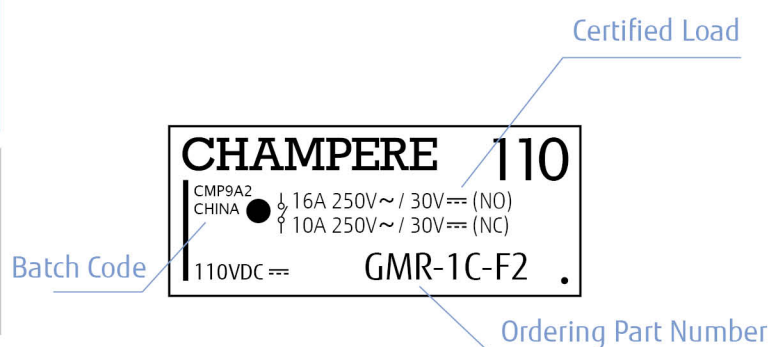

PACKAGE INFORMATION

Package 1: PVC Tray

Inner Package Type & Quantity	100Pcs Per PVC Tray
Outer Package Type & Quantity	500pcs per Carton with Logo and Sticker
Outer Package Dimension & Weight G.W. / N.W.	40 x 30 x 20 cm; 7.3Kgs / 6.7Kgs

Package 2: PVC Tube

Inner Package Type & Quantity	25Pcs Per PVC Tube
Outer Package Type & Quantity	1,000pcs per Carton with Logo and Sticker
Outer Package Dimension & Weight G.W. / N.W.	35 x 27 x 16 cm; 15Kgs / 16Kgs